

屋内照明器具特性

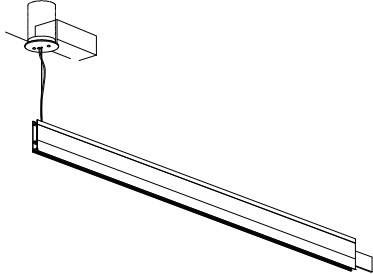

品名	PD-2681-W		
光源	LED60W		
実効光束 (器具光束)	3988lm	効率	66.5lm/W



配光曲線図

実光度

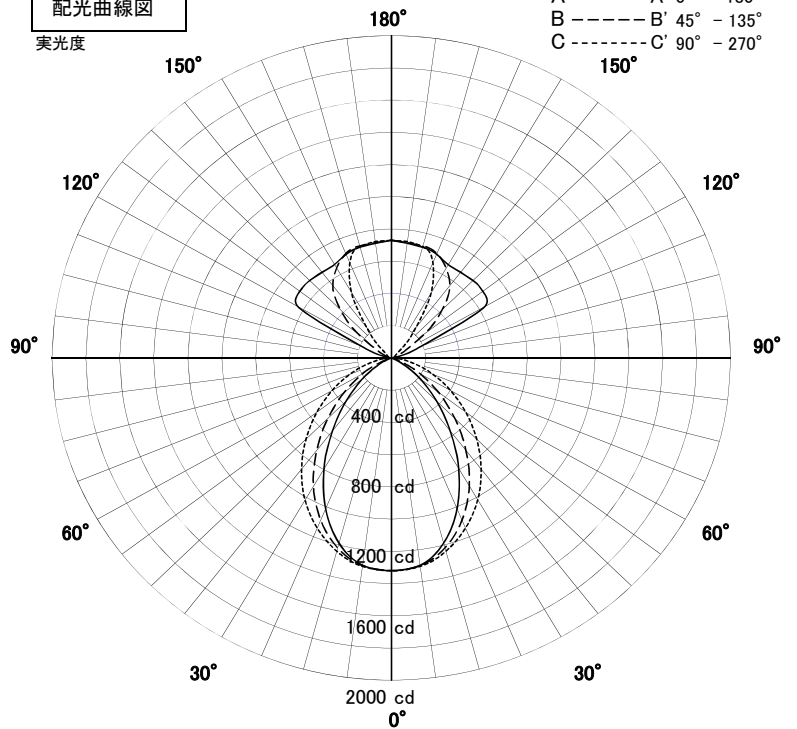

直射水平面照度

単位: Lx

A-A' Section

C-C' Section

色温度	4000K	
演色評価指数	Ra83	
保守率	良	0.63
	中	0.60
	否	0.56
1/2照度角		
A-A'	52.0	Deg
C-C'	60.0	Deg
最大取付間隔		
A-A'	0.98	H
C-C'	1.15	H

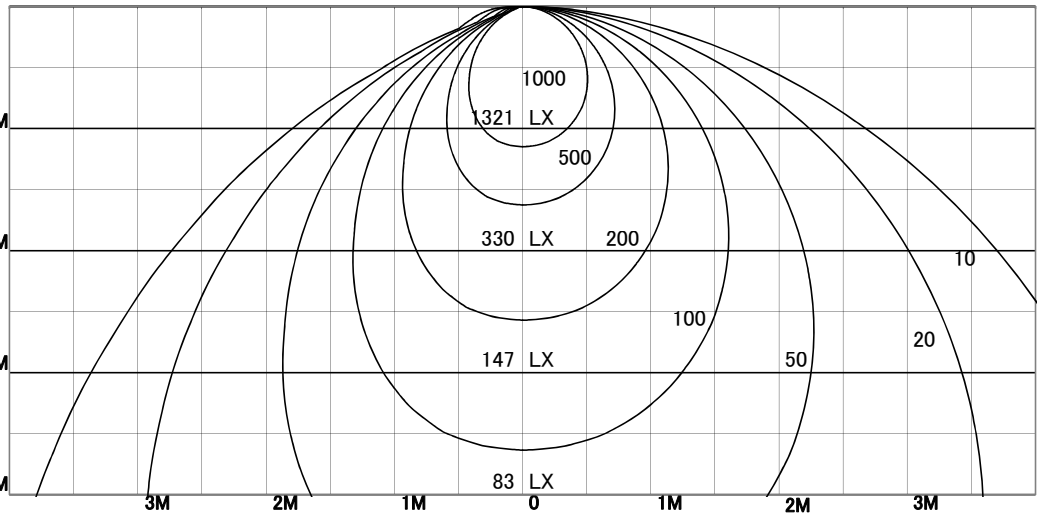

照明率表

	80%				70%				50%				30%				0%
	70%	50%	30%	10%	70%	50%	30%	10%	70%	50%	30%	10%	70%	50%	30%	10%	0%
天井																	
壁																	
床		10%				10%				10%				10%			0%
0.60	39	33	29	26	38	32	29	26	37	32	29	26	36	31	28	26	25
0.80	44	38	34	32	43	38	34	31	42	37	34	31	40	36	33	31	30
1.00	48	43	39	36	47	42	39	36	45	41	38	36	44	40	38	36	34
1.25	51	46	43	40	50	46	43	40	49	45	42	40	47	44	42	40	38
1.50	53	49	46	43	52	49	46	43	51	48	45	43	49	47	44	42	41
2.00	56	53	50	48	55	52	50	48	54	51	49	47	52	50	49	47	46
2.50	58	55	53	51	57	55	53	51	56	54	52	50	54	53	51	50	48
3.00	59	57	55	53	58	56	55	53	57	55	54	52	56	54	53	52	50
4.00	60	59	57	56	60	58	57	55	58	57	56	55	57	56	55	54	53
5.00	61	60	59	57	60	59	58	57	59	58	57	56	58	57	56	55	54
7.00	62	61	60	59	61	60	60	59	60	59	58	58	59	58	57	57	55
10.00	63	62	61	61	62	61	61	60	61	60	59	59	59	59	58	58	56